

REPAIR MANUAL FOR "GC-1" AND "MC-1" SERIES LOW-CAPACITY SMITH PUMPS

This manual contains valuable repair information for the "GC-1" and "MC-1" model types including the following use-specific modifications: "GC-1", "GC-1 L", "GC-1 LZ", "NS", "SA", "NSSA" and "S" versions of the same; "MC-1", "MC-1 L", "MC-1 LZ", "NS", "SA", "NSSA", and "S" versions of the same. Proper procedures are mentioned for changing a mechanical shaft-seal assembly, idler gear shafts, gear set, and bypass valve parts. This manual is an addendum to other repair manuals, parts views, illustrations, and parts lists.

To accomplish a pump repair, the pump must be depressurized. This procedure must be performed according to all applicable Safety Codes and practices consistent with local, State, or Federal Law, and company procedures. NFPA-58 should be consulted. If you do not know how to safely depressurize the pump and isolate it from the piping system, either contact your immediate supervisor, call our local representative, or communicate with us at 805 / 498 - 6616. After the pump has been safely depressurized and isolated by valving-off the pump from the piping system, the following procedure as described in this manual and others should be followed.

A repair kit generally consists of an "MC-100" or "MC-100Z" shaft-seal assembly, a drive gear ("649-5", "649-5 NS", "649-5 L", "649-5 NSL"), two idler gears with bushings ("649-6", "649-6 NS", "649-6 L", "649-6 NSL"), a gear end cover bushing ("649-11"), o-ring for valve cap on "MC-1" Series only ("6227-12"), o-ring for valve seat in "GC-1" series only ("6227-14"), and a drive coupling insert ("FD-20") or a complete drive coupling ("VC-20").

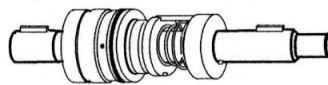

Figure 1. Typical Shaft-Seal Assembly for "GC-1" and "MC-1" Series



Figure 2. Typical gear set for "GC-1" and "MC-1" Series, consisting of one drive gear ("649-5" configuration), and two idler gears with bushings ("649-6" configuration). The drive gear is always the center gear.

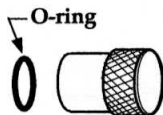

Figure 3. O-ring for Valve Cap "6227-12", "MC-1" Series Only.

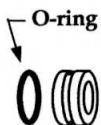

Figure 4. O-ring for Valve Seat "6227-14", "GC-1" Series Only.

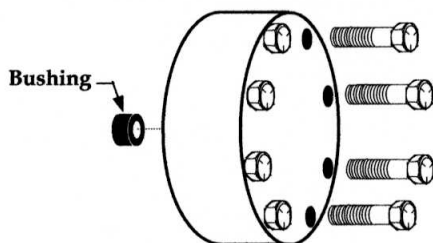

Figure 5. Main Shaft Bushing for Cover "649-11".

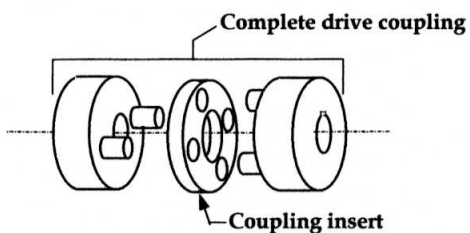

Figure 6. Drive Coupling "VC-20" with Coupling Insert "FD-20".

FOR A SHAFT-SEAL ASSEMBLY REPLACEMENT

STEP 1.

Separate the pump and motor. Four bolts hold the pump onto the motor. These bolts pass through the mounting flange of the pump shaft end cover and screw directly into the motor face.

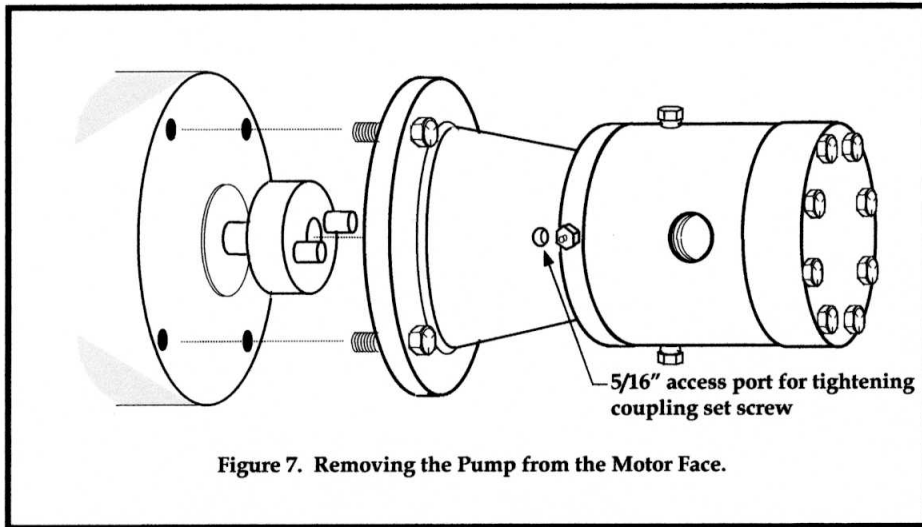

Figure 7. Removing the Pump from the Motor Face.

STEP 2.

Remove the eight cap screws that attach the gear end cover to the main housing, and remove the gear end cover, being very careful not to damage the shaft bushing. Slide the drive gear (center gear) off the drive shaft, and remove the drive gear key. Locate the setscrew in the coupling half mounted to the pump drive shaft. In the configuration shown above, access to the setscrew is through a 5/16" hole drilled through the flanged shaft end cover as shown. Insert an Allen Wrench through this hole to loosen the setscrew, and remove the coupling half from the pump drive shaft.

Remove the small screws from the bearing retainer plate, which is exposed once the coupling half is removed from the pump drive shaft. With a properly sized soft metal drift, lightly tap the gear end of the drive shaft to remove the shaft-seal assembly straight out of the pump from the flanged end of the assembly.

The bearing retainer plate cannot be removed from the shaft-seal assembly until the coupling drive key is removed. Remove the drive key, and the bearing retainer plate from the coupling end of the shaft-seal assembly. Check the bearing retainer plate for damage. If it is in good condition, use it again for the replacement shaft-seal assembly. If not, replace it.

STEP 3.

Closely examine the inside of the shaft end cover from which the shaft-seal assembly was removed. A protective device is installed in the "leak detection port" or "bleed exit" from this area. Since it is open to the outside, a certain amount of excess paint from the installation, grime, rust, or dirt can become lodged in this seal bleed exit area. If the bore appears dirty, carefully remove all deposits and clean the area as best you can. Fine sand paper or emery cloth may be used for this operation, taking care not to damage the machined surfaces. Be sure that the seal leak detection port is not plugged with debris or rust when reassembling the shaft-seal assembly into the pump casing.

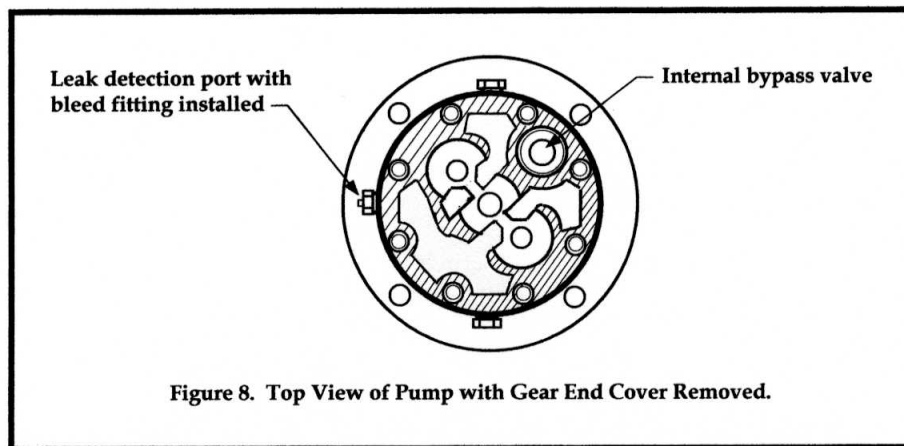

STEP 4.

Apply a small amount of grease to the inside of the pump housing where the shaft-seal assembly will be installed. This will make the installation easier. Never use oil or WD-40 type lubricants.

Now, remove the coupling drive key and the gear drive key from the replacement seal assembly, install the bearing retainer plate, and replace the coupling drive key. Be sure the key is properly seated in the bottom of the keyway. Slide the replacement shaft-seal assembly with the bearing retainer plate, and coupling key, into place. Do not use a hammer to drive the replacement seal assembly in place. It should slide easily. If the shaft-seal assembly cannot be installed easily due to too much resistance, remove it and check for burrs and deposits which were not removed prior to installation. Clean the bore again, and reinstall the seal assembly.

STEP 5.

Once the seal assembly has been properly installed into the housing, insert the screws through the bearing retainer plate, and tighten them securely. Also, since the drive coupling is inside the shaft end cover and not visible from the outside for inspection, this is a good time to inspect the coupling and the coupling insert. If they are damaged, replace them.

Then slide the coupling half with the pins facing away from the bearing retainer plate, onto the shaft and move it inward until the shaft end is even with the end of the coupling bore. Insert an Allen Wrench through the 5/16" access hole in the flanged shaft end cover, and tighten securely. See "Figure 7" and "Figure 6". Install the drive gear key securely into the drive gear keyway. *Do not install the gears or the gear end cover at this point. Proceed with the internal inspection procedure, as follows.*

INTERNAL INSPECTION PROCEDURE



**QUICK
VISUAL
WEAR
CHECK**

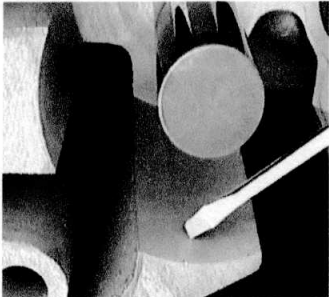

Checking for wear on the pocket diameters.

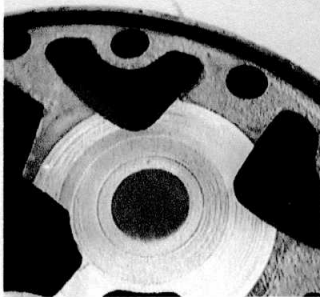

Normal gear end cover face with no functional wear.

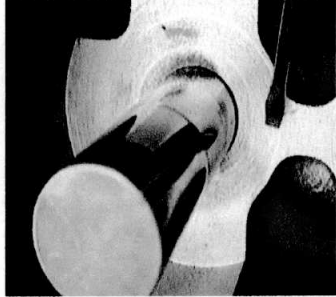

Checking for wear on the pocket ends.

Frequently, a quick visual inspection can save time. For example, if there are visible signs of excessive material removal from the areas shown, the pump cannot be repaired. However, if there is no visible wear, the casings can be used again, and the pump can be repaired.

STEP 1.

Since the gear end cover has already been removed from the pump, now is a good time to check the gears, idler gear shafts, casings, and bypass valve parts for wear and proper fit. First, do a simple visual casing check in accordance with the three pictures, above.

STEP 2.

If the casings appear to be in good condition, check the idler gear shafts, which are pressed into the main housing. Make sure that they are not worn on the side, which resists the pressure. If these pins are worn, replace them. The shaft end cover will have to be removed from the main housing, and a press with a suitable fixture is required to remove the old shafts, and install the new ones. Be sure that if this is done, the new pins are installed about .003 - .005 inches (0.08 - 0.12 mm) below the sealing face of the main housing. After the pins are replaced, be sure to clean the two mating casing faces, with a broad-bladed knife or some other such instrument. Be sure the faces are clean and flat. Apply the recommended sealant sparingly to the main housing face only. Follow the procedure under the section of this manual entitled "RESEALING THE GEAR END COVER ONTO THE MAIN HOUSING" on page 10. Be sure that the shaft end cover is oriented as shown in "Figure 9", below.

STEP 3.

Once this is accomplished, proceed with a visual gear inspection. Check the tooth profile of the drive gear. Compare the working side of a typical gear tooth to the non-working side. If a discernible difference can be visualized in the curvature of one side, as compared to the other side, the gear set will have to be replaced. After examining the drive gear profile, continue the visual inspection by checking for signs of missing gear tooth material, and wear on the diameters and ends of all gears. *It is very important that the gear ends be flat, and have no surface irregularities. If any discrepancies are noticed, the gear set must be replaced before reassembling the pump.* With a complete gear set in good apparent condition (as confirmed by the visual inspection previously discussed), the casing clearances may be measured in the following manner:

Slide the drive gear onto the drive shaft, into position in the main housing drive gear bore. Install the idler gears (upper and lower) onto the idler gear shafts. Check the fit of the idler gear bushings on the shafts for excessive looseness. This clearance must be a "tight sliding fit", between 0.002 - 0.003 inches (0.05 - 0.08 mm). Once this clearance has been verified as correct, check the gear length clearance.

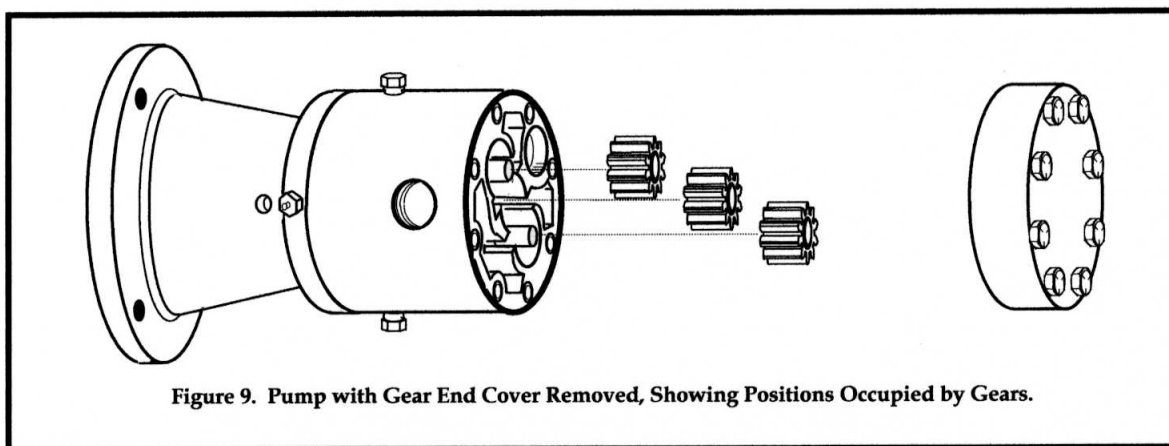

Figure 9. Pump with Gear End Cover Removed, Showing Positions Occupied by Gears.

Placing a suitable tool with a straight edge across the main housing face, use a feeler gauge to measure the distance between the straight edge and the face of each gear. If there is no measurable wear by the gear faces into the gear end cover, this measurement determines the *total* gear end play. This total gear end play should never exceed 0.004 inches (0.10 mm).

Next, use two feeler gauge blades simultaneously between the left and right sides of each gear and the corresponding walls of the gear pockets. Begin with the drive gear (center gear) installed in the main housing. The sum of the two measured widths in this case should never be more than 0.005 inches (0.13 mm).

Check the length clearance and the diametral clearance around the two driven gears in the same fashion. The maximum clearances are the same for these gears as they are for the drive gear. If the gear clearance measurements are beyond maximum, it is usually because the excessive wear on the used gear set was not noticed during the visual inspection. When this is determined to be the case, discard the used gear set, install a brand new gear set, and take all the measurements again. Once the gears have passed these two inspections, measure the "backlash". Insert a feeler gauge between the meshing gear teeth, first in the top gear combination, and then, in the bottom one, where the drive gear meshes with the two idler gears. This measurement will indicate the total amount of tooth wear and working diametral clearance. The actual maximum backlash with the gears installed in the pump is 0.016 inches (0.40 mm). Therefore, when measured with a feeler gauge, if a 0.014" (0.35 mm) gauge can be fitted between the meshing teeth, there is essentially too much clearance in the pump for an acceptable repair which will last a reasonable amount of time.¹ If the gears pass this inspection, proceed with a visual inspection of the bypass valve parts.

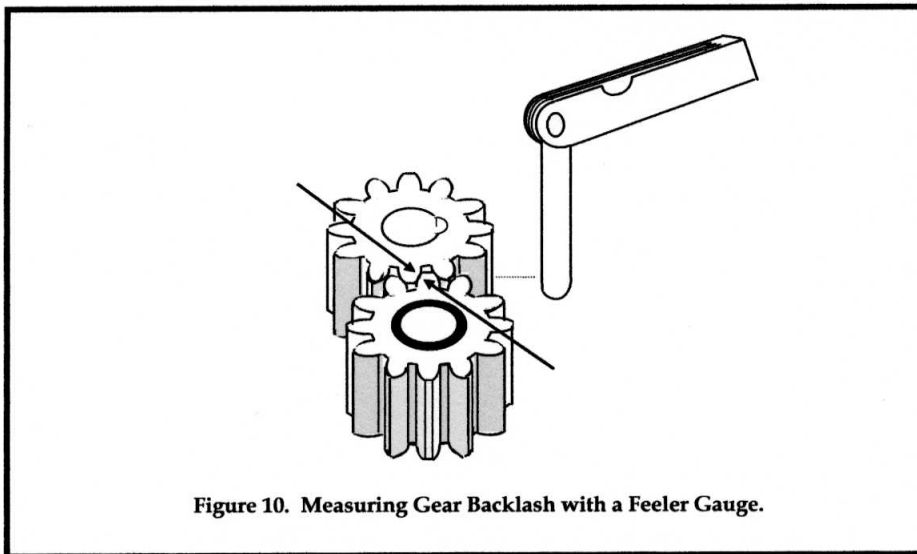
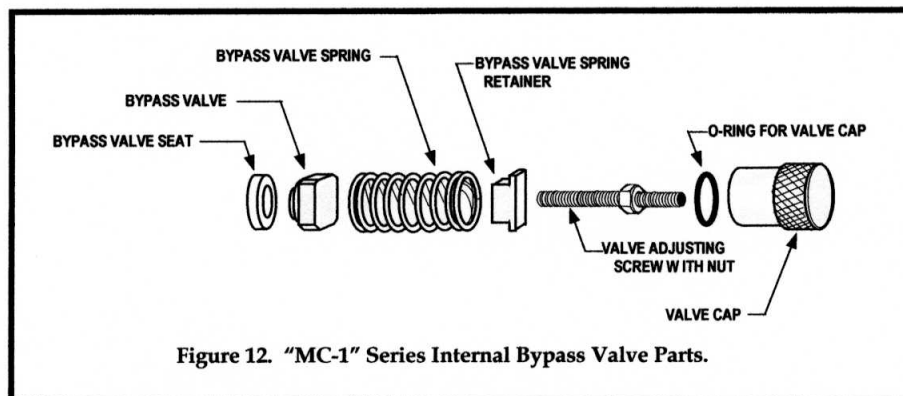
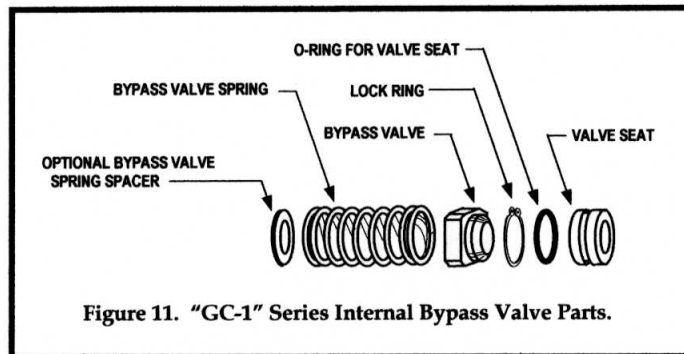

Figure 10. Measuring Gear Backlash with a Feeler Gauge.

STEP 4.

¹ The used gears may be turned around so the wear occurs on the opposite sides of the gear teeth, but only when they have been properly measured, and certified to be within the acceptable tolerances. *Never re-use a gear set which is worn beyond maximum tolerance, even if one side of the gear teeth appears to not be worn.*

The "GC-1" Series and the "MC-1" Series have different internal bypass valve configurations. Please refer to the following drawings, "Figure 11" and "Figure 12".



Note that with the "GC-1" configuration as shown in "Figure 11", all the bypass valve parts are internal, and installed in the main housing only. With the "MC-1" configuration, the bypass valve seat, valve, spring, and spring retainer are installed in the main housing; and the remainder of the parts, the valve adjusting screw with nut, the o-ring, and the valve cap are installed on the gear end cover.

If the pump is a "GC-1" type, remove the valve seat with o-ring. With the appropriate lock ring pliers, remove the lock ring, then remove the valve, spring, and optional spacer if used. Visually inspect all of these parts for wear or damage. It is a good idea to replace the lock ring each time it is removed to inspect the valve parts. Replace the o-ring if it appears to be flat, worn, damaged, or deformed in any way. Replace the valve seat if the valve contact area is worn, eroded, or damaged in any way.

Likewise, replace the valve if it is worn or deformed in any way. Check the rounded corners for wear and replace it, if it fits loosely in the bore. Check the seat contact area, and replace the valve if there is wear or pitting. Inspect the valve spring and replace it if it is deformed, cracked, or broken.

If the pump is an "MC-1" type, remove all of the parts from the main housing which include the spring retainer, spring, valve, and seat. The seat is press-fitted into the bottom of the bore in the main housing, and must be carefully removed with a press. Do not tap or hammer it out of the casing, as it is made of a relatively soft material and can be easily damaged. Visually inspect all of these parts for signs of damage and wear as with the "GC-1" parts described, above.

Next, remove the valve cap from the end of the valve adjusting screw, which protrudes through the gear end cover. Remove the o-ring from the cap and check for damage and deformation. Replace the o-ring if it is flat, hardened, damaged, or deformed in any way. Check the condition of the o-ring groove in the cap for cracks, corrosion, or other damage. Check the threads inside the valve cap for signs of stripping or other damage. Replace the cap if necessary.

The last part of this procedure regarding the "MC-1" models is to carefully observe the condition of the valve adjustment screw and the lock nut. The screw is adjusted properly at the factory, and there usually is no need to replace it, or change the original internal bypass setting. Check for corrosion, deformation, or other damage. Be sure that there is sufficient length protruding from the gear end cover to properly support and retain the valve cap. This is important, because the cap is under pressure when the pump is exposed to the handled fluid.

Keep in mind that subsequent readjustment of the internal bypass valve cannot be properly made in the field, by simply setting the screw to a certain distance from the cover. The bypass valve can only be preadjusted in this manner to an *approximate* setting, and must be then fine-tuned under dynamic conditions. If the adjustment screw must be replaced or adjusted in the field, contact the factory, or our nearest representative, for further instructions.

Once these steps are completed, and the bypass valve parts are determined to be in good condition, reassemble them to the casings, in proper sequence, as per the assembly drawings in "Figure 11" or "Figure 12". With the "GC-1" Series, make sure that the lock ring properly engages the groove before inserting the valve seat.

Now that all the internal parts and casings have been certified to be in good condition, the final procedure is to reseal and mount the gear end cover onto the main housing.

RESEALING THE GEAR END COVER ONTO THE MAIN HOUSING

STEP 1.

Smith pumps do not utilize casing gaskets. A light coating of sealant is applied to the main housing only, to effect a positive seal against leakage to atmosphere. Before this sealant can be applied, the mating faces must be clean. *Be sure to remove the gears from the main housing, before applying the sealant.*

With a broad-bladed knife, or some other such instrument, carefully remove all of the original casing sealant from all the exposed sealing faces. Make sure that these surfaces are clean and flat before proceeding. Apply casing sealant very sparingly with a sponge applicator, or by hand, *to the main housing face only*. Do not apply the sealant to the gear end cover. There are only a very few sealants which can be used in this application.²

Cover the entire sealing surface, and then remove the sealant by hand or with a sponge applicator, approximately 1/16 - 1/8 inch (1.5 - 3 mm) back from the inside edges to prevent excessive sealant from depositing inside the pump when the cover is tightened-up. Do not use a rag for this purpose. Do not use contaminated sealant. Use only the recommended sealant.³ Be careful not to allow any debris, brush hairs, cloth fibers, or dirt, between the joined surfaces.

STEP 2.

Before placing the gear end cover over the end of the main housing, check the condition of the main shaft bushing installed in the center of the gear end cover. The internal surface should not be worn, or cracked. It should have a tight sliding fit (0.002 - 0.003 inches) (0.05 - 0.08 mm) on the end of the drive shaft. The old bushing can be chipped-out if done carefully in order not to damage the bore surface. The new bushing must be installed with a press, being careful to maintain proper alignment while pressing it into position, slightly below the sealing surface.

² We recommend the use of either of two sealants manufactured by Federal Process Corp.: "Gasola Soft-Set" or "Plastic Lead Seal No. 2", both of which are Teflon®-based thread sealants, for use as a casing face sealant in Smith LPG pumps. Be sure to always follow *all* safety recommendations. Services other than LPG transfer, may require different sealants and special cleaning techniques. If there are any questions about compatibility, contact the factory for specific information. Never utilize a Smith pump for handling any liquid(s) other than those specifically stamped on the pump tag. If there are any questions about compatibility, contact the factory for specific information.

³ *Never assemble the casings without applying the correct sealant in the recommended manner. Following this procedure improperly will lead to pump failures, and casing leaks to atmosphere.* There are certain non-recommended sealing compounds which may be incompatible with the liquid(s) handled or the pump construction materials. They are not recommended by their respective manufacturers, or by us, for use in this type of handling equipment. In general terms, the sealants which should be avoided are either of the wrong viscosity, incompatible with handled liquid(s), harden too quickly, or contain potentially problematic components such as acids, solid particles, debris accumulations, rubber, dirt, fibers, resins, and greases.

Install the gears into the main housing. Turn the drive shaft to make sure there is no binding. If the gears turn freely, assemble the cover onto the main housing, insert the eight cap screws, and tighten initially slightly more than hand tight, in a circular fashion. Then torque them to 20-25 ft-lbs (27-34 N•m). Allow the sealant to dry for a few hours, preferably over night. Before exposing the pump to pressure, be sure to check the torque again on all the gear end cover cap screws. Make sure none of the cap screws are missing, or defective in any way.

Once the torque has been checked, follow recommended procedure to pressure-test the unit before placing it into service. Contact the factory, if there are any questions. As recommended previously, all procedures must be done in an approved, safe manner. Always follow all applicable safety codes, regulations, and company procedures.



SMITH PRECISION PRODUCTS COMPANY

P.O. Box 276, Newbury Park, CA 91319 USA

1299 Lawrence Drive, Newbury Park, CA 91320 USA

Tel.: 805/498-6616 FAX: 805/499-2867

e-mail: SMPUMP1299@aol.com **web: www.smithpumps.com**